

13-43 m  
178-580 m  
700-2000 m  
3000 16, 20, 25, 30, 50 m  
974 A = 468 kHz

9632 R-57  
110 V, 125 V, 145 V  
200 V, 225 V, 245 V  
85 Watt  
974 A-19 = 432 kHz

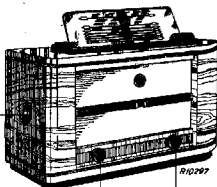

700-2000 m		178-580 m							
<p>⊕ C69 max. C55-82 pF C60 max. C60-82 pF C66-82 pF C55 max. C70 max. C70-82 pF</p>	<p>⊕ C11, C29, C46 min. 468 kHz-33000 pF-gIR2 C69-82 pF C70 max. C70-82 pF</p>	<p>⊕ C11, C29, C46 + 15° 1520 kHz- C36, C30, C1 max. -25 pF-B2 600 kHz- C11, C29, C46 600 kHz C44 max. C11, C29, C46 + 15° 1520 kHz- C36, C20, C1 max.</p>	<p>⊕ C11, C29, C46 + 15° 410 kHz- C38, C21, C2 max. -25 pF-B2 150 kHz- C11, C29, C46 150 kHz C50 max. C11, C29, C46 + 15° 410 kHz- C38, C21, C2 max.</p>						
178-580 m		700-2000 m							
13-43 m									
<p>⊕ C11, C29, C46 + 15° 1520 kHz- C36, C30, C1 max. -25 pF-B2 600 kHz- C11, C29, C46 600 kHz C44 max. C11, C29, C46 + 15° 1520 kHz- C36, C20, C1 max.</p>	<p>⊕ C11, C29, C46 + 15° 410 kHz- C38, C21, C2 max. -25 pF-B2 150 kHz- C11, C29, C46 150 kHz C50 max. C11, C29, C46 + 15° 410 kHz- C38, C21, C2 max.</p>	<p>⊕ C11, C29, C46 + 15° 20,84 MHz- C45, C22, C3 max. 7,5 MHz- C11, C29, C46 (7,5 MHz) SX max. C11, C29, C46 + 15° 20,84 MHz- C45, C22, C3 max.</p>	<p>⊕ C11, C29, C46 + 15° 20,84 MHz- C45, C22, C3 max.</p>						
16 m.		20 m.		25 m.		30 m.		50 m.	
<p>⊕ C11, C29, C46 16,85 m 17,8 MHz- C39, C23, C4 max.</p>	<p>⊕ 19,71 m 15,925 MHz</p>	<p>⊕ 25,42 MHz 11,8 MHz</p>	<p>⊕ 31,25 MHz 9,6 MHz</p>	<p>⊕ 49,18 MHz 6,1 MHz</p>					
		C40, C24, C5		C41, C25, C6		C42, C26, C7		C43, C27, C8	
15° 0999244.0									

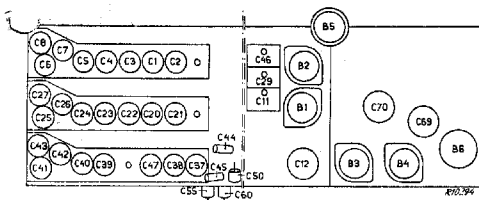

	B1	B2	B3	B4	B5	B6
EF22		ECH22	ECH21	EBL21	EM4	1823
V <sub>a</sub>	225	±T 130 ±H 230	±T 90 ±H 230	285	55	50
V <sub>g2</sub> (4)	100	105	75	305	235	
V <sub>k</sub>	2,1	2,4	1,6	11,5	11,5	
I <sub>a</sub>	6,2	±T 5,8 ±H 2,3	±T 5,8 ±H 4,6	38	0,2	0,2
I <sub>g2</sub> (4)	2	4,3	3,7	4,2	2	

C1	3-30 pF	28 212 36.0	C77	4700 pF	49 129 18.0
C2	3-30 pF	28 212 36.0	C78	0.1 pF	49 127 36.0
C3	3-30 pF	28 212 36.0	C79	56000 pF	49 127 36.0
C4	3-30 pF	28 212 36.0	C80	0.22 pF	49 127 36.0
C5	3-30 pF	28 212 36.0	C81	50 pF	49 029 61.0
C6	3-30 pF	28 212 36.0	C82	45 pF	49 055 22.0
C7	3-30 pF	28 212 36.0	C83	47 pF	49 029 61.0
C8	3-30 pF	28 212 36.0	C84	2.4 pF	
C9	22 pF	49 057 24.0	C85	56000 pF	49 128 23.0
C10	47 pF	49 055 24.0	C86	56000 pF	49 128 23.0
C11	16-30 pF	28 212 36.0	C87	220 pF	49 085 32.0
C12	10-170 pF	28 211 31.0	C88	200 pF	30 211 96.1
C13	47 pF	49 055 24.0			
C14	220 pF	49 055 24.0	R1	0.22 M.Ohm	49 375 59.0
C15	56000 pF	49 127 36.0	R2	270 Ohm	49 375 59.0
C16	47 pF	49 055 24.0	R3	0.82 M.Ohm	49 375 59.0
C17	10 pF	49 055 14.0	R4	180 Ohm	49 375 59.0
C18	56000 pF	49 128 23.0	R5	56000 pF	49 375 59.0
C19	56000 pF	49 128 23.0	R6	17000 Ohm	49 375 44.0
C20	3-30 pF	28 212 36.0	R7	27000 Ohm	49 377 41.0
C21	3-30 pF	28 212 36.0	R8	12000 Ohm	49 375 47.0
C22	3-30 pF	28 212 36.0	R9	3200 Ohm	49 375 28.0
C23	3-30 pF	28 212 36.0	R10	54000 Ohm	49 377 45.0
C24	3-30 pF	28 212 36.0	R11	2x30900 Ohm	49 377 42.0
C25	3-30 pF	28 212 36.0	R12	1000 Ohm	49 375 59.0
C26	3-30 pF	28 212 36.0	R13	150 Ohm	49 375 14.0
C27	3-30 pF	28 212 36.0	R14	0.82 M.Ohm	49 375 59.0
C28	3-30 pF	28 212 36.0	R15	1.8 M.Ohm	49 377 43.0
C29	16-490 pF	49 055 24.0	R16	0.22 M.Ohm	49 375 52.0
C30	220 pF	49 055 32.0	R17	0.47 M.Ohm	49 375 56.0
C31	2.5 pF	28 206 42.0	R18	0.82 M.Ohm	49 375 59.0
C32	220 pF	49 055 32.0	R19	56000 pF	49 375 52.0
C33	56000 pF	49 127 23.0	R20	0.88 M.Ohm	49 500 19.0
C34	220 pF	49 055 32.0		(0.45-0.2)	
C35	33 pF	49 055 14.0	R21	0.22 M.Ohm	49 375 52.0
C36	3-30 pF	28 212 36.0	R22	1 M.Ohm	49 376 00.0
C37	3-30 pF	49 055 22.0	R23	1 M.Ohm	49 376 00.0
C38	3-30 pF	28 212 36.0	R24	0.82 M.Ohm	49 375 59.0
C39	3-30 pF	28 212 36.0	R25	0.47 M.Ohm	49 375 56.0
C40	3-30 pF	28 212 36.0	R26	1.8 M.Ohm	49 377 63.0
C41	3-30 pF	28 212 36.0	R27	180 Ohm	49 375 18.0
C42	3-30 pF	28 212 36.0	R28	1012 36.0	49 375 59.0
C43	3-30 pF	28 212 36.0	R29	1300 Ohm	49 375 26.0
C44	200 pF	28 211 08.1	R30	18000 Ohm	49 376 37.0
C45	12.5 pF	28 212 95.6	R31	10000 Ohm	49 376 26.0
C46	10-490 pF		R32	1 M.Ohm	49 376 00.0
C47	3-30 pF	49 088 20.0	R33	3.3 M.Ohm	49 377 66.0
C48	160 pF	49 055 16.0	R34	5.3 M.Ohm	49 377 66.0
C49	390 pF	49 055 35.0	R35	2200 Ohm	49 356 31.0
C50	3-30 pF	28 212 36.0	R36	0.1 M.Ohm	49 375 48.0
C51	6400 pF	20 198 05.0	R37	18 Ohm	49 376 03.0
C52	56000 pF	49 127 23.0	R38	47000 pF	49 377 44.0
C53	390 pF	49 055 72.0	R39	0.47 M.Ohm	49 375 56.0
C54	390 pF	49 055 72.0	R40	33 Ohm	49 375 08.0
C55	30-70 pF	28 212 36.0	R41	6.1 M.Ohm	49 375 48.0
C56	56000 pF	49 127 23.0	R42	1.8 M.Ohm	49 377 63.0
C57	56000 pF	49 128 23.0	R43	2300 Ohm	49 375 28.0
C58	91 pF	28 194 28.0	R44	33 Ohm	49 376 06.0
C59	1800 pF	49 127 17.0	R45	100 Ohm	49 377 44.0
C60	30-70 pF	28 212 46.0	R46	33 Ohm	49 375 06.0
C61	1000 pF	49 128 53.0	R47	22000 Ohm	49 375 49.0
C62	21000 pF	49 127 17.0	R48	1000 Ohm	49 376 26.0
C63	6.8 pF	49 855 14.0	R49A19	1300 Ohm	49 356 29.0
C64	56000 pF	49 128 23.0			
C65	100 pF	28 185 68.1			
C66	10 pF	49 055 16.0			
C67	56000 pF	49 128 23.0			
C68	27000 pF	49 127 19.0			
C69	30-70 pF	28 212 46.0			
C70	30-70 pF	49 857 65.0			
C71	100 pF	49 127 19.0			
C72	2200 pF	49 127 19.0			
C73	30000 pF	49 127 51.0			
C74	27000 pF	49 127 19.0			
C75	2200 pF	49 128 06.0			
C76	23 pF	49 055 27.0			

S11-86	GK 563 99.1	845-849	GK 562 97.4
S17-810	GK 562 91.1	846-849 (A19)	GK 563 26.0
S11-816	GK 562 92.2	850-853	GK 563 98.5
S17-822	GK 562 85.1	850-853 (A19)	GK 563 00.0
S28, S34	GK 562 87.1	854-857	GK 563 98.1
S25, S26, S27	GK 562 88.2		49 981 07.0
S28-833	GK 562 92.1		A1 001 68.2
S28-833 (A19)	GK 563 01.0	849-854	GK 563 18.0
S25-840	GK 562 95.4		GK 562 98.0
S41-844	GK 562 96.2	866	GK 563 94.0
		867	GK 562 25.0

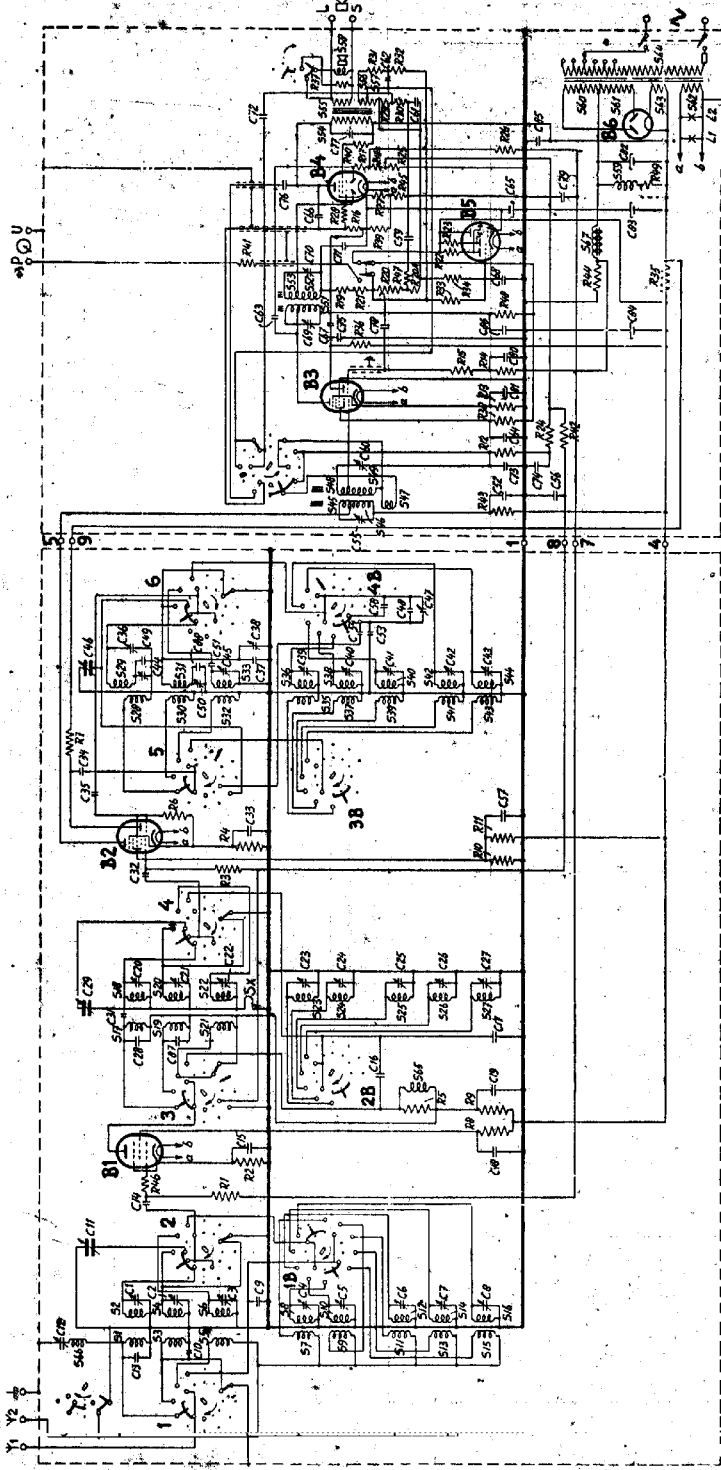

R 10004

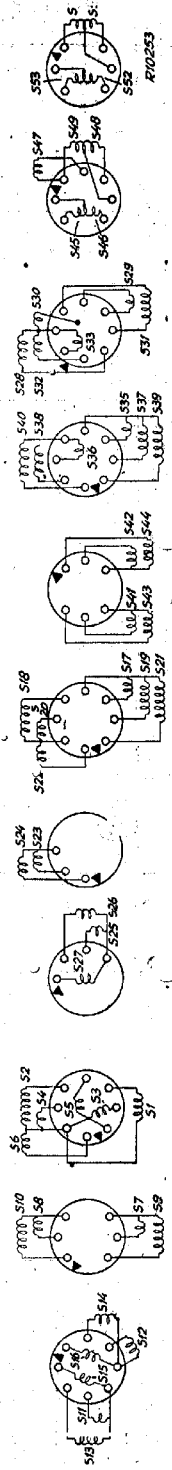

**STRICTLY CONFIDENTIAL**  
FOR PHILIPS SERVICE DEALERS ONLY

COPYRIGHT

# PHILIPS

## SERVICE DOCUMENTATION

for the receiver

# 974 A

FOR A.C. SUPPLY  
EXECUTION -A, -A19

### WAVE RANGES

S.W. Range: 13—45 m ( 23,06—6,68 Mc)  
M.W. Range: 178—580 m (1714 —517,2 kc)  
L.W. Range: 700—2000 m ( 429 —150 kc)  
Bandspread out: 16 m, 20 m, 25 m, 30 m, and 50 m.

### CONTROLS

Left-hand side of front panel:  
pulled out: Mains switch with volume control,  
pressed in: selectivity switch.  
Right-hand side of front panel:  
pulled out: Tuning,  
pressed in: Wave length switch and Bandspread switch.  
Left-hand side of cabinet: Radio-Gramophone switch.  
On the rear side from left to right: Normal aerial dipol-aerial  
switch, Loudspeakerswitch.

### BANDWIDTH

The I.F. bandwidth (1:10) : 10,5 kc.  
measured from G1 of B2, bandwidth switch narrow (turned  
to the left).  
Bandwidth switch in position wide, (turned to the  
right), 16,5 kc.  
The overall bandwidth (1:10) measured from aerial socket:  
at 1000 kc. narrow 9 kc.  
wide 13,5 kc.  
at 200 kc. narrow 9 kc.  
wide 14 kc.

### DIMENSIONS

Width	62 cm	} knobs included
Height	54 cm	
Depth	31 cm	

Weight: 18,0 kg, tubes included.

### TRIMMING THE RECEIVER

Retrimming is necessary when a coil or condenser of a tuned circuit is replaced or when the sensitivity or selectivity is insufficient. Trimming tools are mentioned in the list for spares and tools. The trimming should be done with the chassis in the cabinet as for trimming the spreaded bands the dials readings are required. For balancing some circuits a special key has to be used, see tool-list; for the other trimmers the normal trimming key is sufficient.

### REMARK

The calibration of the bandspread is accurate and difficult to carry out, therefore do not turn these trimmers when not absolutely necessary, especially C47 should not be altered. (See also under „The calibration of bandspread“.) The position of the trimmers is given in fig. 3 and 3a. The I.F. is 468 kc. for execution A and 452 kc. for execution A19.

### A. I.F. CIRCUITS

- 1) Ground the receiver. Switch the set on L.W. Bandwidth control on narrow. Turn the variable condenser on minimum. Switch the Radio-Gramophone switch in position for „Radio“.
- 2) Connect output meter via a trimming transformer to the extension loudspeaker sockets.
- 3) Apply a modulated signal of the I.F. to the control grid (g1) of B2.
- 4) Detune S50-S51 by connecting a condenser of 82 pF in parallel with C69. Trim C70 for maximum output. Remove detuning condenser.
- 5) Detune S52-S53 with the condenser of 82 pF in parallel with C70. Trim C69 to maximum output. Remove detuning condenser.
- 6) Detune S45-S46 with 82 pF in parallel with C55. Trim C60 to maximum output. Remove detuning condenser.

- 7) Detune S48-S49 with 82 pF in parallel with C60. Trim C55 to maximum output. Remove detuning condenser.
- 8) Seal the trimmers.

### B. I.F. FILTER

- 1) Connect the receiver like under points A1 and 2, however, the wave range switch on medium wave and variable condenser on maximum.
- 2) Apply a modulated I.F. signal via a normal artificial aerial to the aerial socket.
- 3) Trim C12 to minimum output and seal the trimmer.

### C. H.F. AND OSCILLATOR CIRCUIT

#### a. Medium wave range (178-580 m)

- 1) Set the wave range switch at M.W., bandwidth switch on small (midst position). Radio-Gramophone switch at „Radio“ and aerial switch at normal aerial.
- 2) Connect the outputmeter via a trimming transformer to the extension loudspeaker sockets.
- 3) Set the variable condenser to the 15° jig (smallest capacity).
- 4) Apply a modulated signal of 1520 kc. via the normal artificial aerial to the aerial socket.
- 5) Trim respectively C36, C20, C1 for maximum output.
- 6) Connect an aperiodic amplifier or an auxiliary receiver via a condenser of 25 pF to the anode of B2 and output meter to the amplifier or auxiliary receiver.
- 7) Apply a modulated signal of 600 kc. via the normal artificial aerial to the aerial socket of the receiver to be trimmed.

- 8) Accurately tune both receivers with the tuning knobs to this frequency. Do not turn any more the variable condenser.
- 9) Disconnect the auxiliary amplifier. Connect output meter to the receiver under test.
- 10) Trim C44 for maximum output.
- 11) Turn the variable condenser against 15° gauge. (smallest capacity).
- 12) Repeat the operation, mentioned under 4 and 5; seal the trimmers.

#### b. Long wave range (700-2000 m.)

- 1) Apply the same operation as mentioned under C, a, 1, 2 and 3, however, wavechange switch on L.W.
- 2) Apply a modulated signal of 410 kc. via the normal artificial aerial to the aerial socket.
- 3) Trim successively C38, C21, C2 for maximum output.
- 4) Connect an aperiodic amplifier or an auxiliary receiver via a condenser of 25 pF to the anode of B2 and the output meter to the amplifier or auxiliary receiver.
- 5) Apply a modulated signal of 150 kc. via the normal artificial aerial to the aerial socket of the receiver to be trimmed.
- 6) Accurately tune both receivers with the tuning knobs to this frequency. Do not turn any more the variable condenser.
- 7) Disconnect the auxiliary receiver and connect the output meter after the receiver to be trimmed.
- 8) Trim C50 for maximum output.
- 9) Turn the variable condenser against 15° jig (smallest capacity).
- 10) Repeat the operation under 2 and 3; seal the trimmers.

#### c. Short wave range (13-43 m)

- 1) Connect the receiver as mentioned under C, a, 1, 2 and 3, however, wavechange switch in shortwave position.
- 2) Apply a modulated signal of 20.84 Mc, via the short wave artificial aerial to the aerial socket.
- 3) Trim successively C45, C22, C3 for maximum output.
- 4) Apply a modulated signal of 7.5 Mc, via the short wave artificial aerial to the aerial socket.
- 5) Accurately tune the receiver to this frequency. Do not turn any more the variable condenser.
- 6) Trim for maximum output by alteration of the turns of Sx (see fig. 2a).
- 7) Turn variable condenser against 15° jig.
- 8) Repeat operation under 2 and 3 and seal the trimmers.

#### Adjusting the tuning scale

- 1) Connect the receiver as mentioned under C, a, 1, 2, however, wavechange switch on M.W.
- 2) Apply a modulated signal of 857 kc, via normal artificial aerial to the aerial socket.
- 3) Tune the receiver accurately to this frequency.
- 4) Loosen knurled screw of course slightly and place the pointer exactly on 350 m, without altering the tuning.
- 5) Fix the knurled screw.

#### Adjustment of the bandspread

The trimmer C47 should never be altered, together with C48, it forms a fixed capacity. When C47 becomes faulty, it has to be replaced together with C48. Before adjusting the spreaded bands, the scale should be checked on M.W.

#### REMOVING AND CHANGING OF PARTS

Most repairs can be carried out without taking the chassis from the cabinet. When removing the chassis from the cabinet, this should be done in the following manner:

- 1) Remove knobs.
- 2) Remove the radio-gram. switch from the cap.
- 3) Unsolder the connections to the pilot lamps and loudspeaker.

#### a. 16 m band

- 1) Connect the receiver as mentioned under C, a, 1 and 2, turn, however, the wavechange switch on the 16 m band.
- 2) Place pointer with tuning knob exactly on 16.85 m.
- 3) Apply a modulated signal of 17.8 Mc (see Note) via S.W. artificial aerial to the aerial socket.
- 4) Trim for maximum output C39, C23, and C4. Seal C23 and C4.

#### b. 20 m band

- 1) Connect the receiver as mentioned under C, a, 1 and 2, however, wavechange switch on 20 m band.
- 2) Place pointer with tuning knob exactly on 19.71 m.
- 3) Apply a modulated signal of 15,225 Mc. (see Note) via S.W. artificial aerial to the aerial socket.
- 4) Trim for maximum output successively C40, C24 and C5. Seal C24 and C5.

#### c. 25 m band

- 1) Connect the receiver as mentioned under C, a, 1 and 2, however, the wavechange switch on 25 m.
- 2) Place pointer with tuning knob exactly on 25.42 m.
- 3) Apply a modulated signal of 11.8 Mc. (see Note) via S.W. artificial aerial to aerial socket.
- 4) Trim for maximum output successively C41, C25 and C6. Seal C25 and C6.

#### a. 30 m band

- 1) Connect the receiver as mentioned under C, a, 1 and 2, however, wavechange switch on 30 m.
- 2) Place pointer with tuning knob exactly on 31.25 m.
- 3) Apply a modulated signal of 9.6 Mc. (see Note) via S.W. artificial aerial to aerial socket.
- 4) Trim for maximum output successively C42, C26 and C7. Seal C26 and C7.

#### b. 50 m band

- 1) Connect receiver as mentioned under C, a, 1 and 2, wavechange switch, however, on 50 m.
- 2) Place pointer with tuning knob exactly on 49.18 m.
- 3) Apply a modulated signal of 6.1 Mc. via S.W. artificial aerial to aerial socket.
- 4) Trim for maximum output successively C43, C27 and C8. Seal S27 and C8.

#### Note

As it is not possible to tune the service oscillator accurately enough on the required frequencies of the spreaded bands, one of the following procedures may be used to obtain satisfactory results.

- 1) Adjust the service oscillator on the required frequency with the aid of a good functioning and accurately calibrated receiver with band spread. For this purpose adjust the auxiliary receiver on the required frequency in bandspread position, connect the short wave dummy aerial of the service oscillator to the aerial socket of the auxiliary receiver and tune the service oscillator for maximum output.
- 2) Apply this same signal of the service oscillator to the receiver to be trimmed, accurately tune it to this signal and adjust the trimmers of the oscillator circuit for maximum output on well-known short wave stations. These trimmers are in the 16 m band: C39, in the 20 m band: C40, in the 25 m band: C41, in the 30 m band and in the 50 m band C43. After checking the scale calibration in bandspread position on short wave stations, the trimmers can be sealed.

- 4) Remove valve holder of magic-eye from bracket.
- 5) Loosen cable for wave range indication.
- 6) Slightly loosen the knurled screw of pointer cursor.
- 7) Take the cable from the guiding roll in the left top corner of the cabinet; keep the cable stretched and fix it with a clamp to the bracket of the left guiding roll in the lower part of the cabinet.

## TJELJIVO

## RESISTANCES

- 8) In the same way remove the cable from the guiding roll in the right top corner and clamp it to the right lower roll. The purpose of this operation is to prevent that the cable falls off the driving drum.
- 9) Loosen the six bottom screws and take the chassis out of the cabinet.

## C47 and C48

C47 is together with C48 trimmed for a certain capacity, therefore never alter the position of C47. Has C47 been turned, both C47 and C48 have to be renewed.

## I.F. transformer

When renewing the second I.F. transformer, a special lever has to be used. (See list of spare parts and tools).

## Cables

Fig. 6 shows the course of the cables.

The length of the driving cable for the variable condenser is 510 mm.

The length of the cable between Philite drum and the drum of the variable condenser is

730 mm.

Driving cable of pointer is

920 + 920 mm.

Cable for wave range pointer is

735 mm.

The length is taken between the fixing points, for the loops an additional length is required.

## A-19 execution

The only difference between the normal and the A-19 execution is the resistance R49, which is with the latter in series with the excitation coil of the loudspeaker.

## CURRENTS AND TENSIONS

	B1	B2	B3	B4	B5	
Va	225	Triode 130 Hexode 230	Triode 80 Hexode 230	285	55	Volt
Vg (2+4)	100	105	75	305	235	Volt
Vk	2,1	2,4	1,6	11,5	11,5	Volt
Ia	6,3	Triode 5,8 Hexode 2,3	Triode 5,8 Hexode 4,6	38	0,2	mA
Ig* (+4)	2	6,3	3,7	4,2	2	mA

Vc84 = 235 Volt

Vc83 = 305 Volt

Vc82 = 330 Volt

I excitation coil of speaker 42 mA.

Primary consumption: ± 85 watt.

The voltages are measured with meters having a resistance of 2000 ohms per volt. No signal on the aerial socket, wave length switch on M.W.; variable condenser in maximum position; pick-up switch in „radio“ position.

Nr.	Value	Code number	Price
R1	0,82 M.Ohm	49 375 59.0	
R2	270 Ohm	49 375 17.0	
R3	0,82 M.Ohm	49 375 59.0	
R4	180 Ohm	49 375 15.0	
R5	0,22 M.Ohm	49 375 52.0	
R6	47000 Ohm	49 375 44.0	
R7	27000 Ohm	49 377 41.0	
R8	82000 Ohm	49 375 47.0	
R9	2200 Ohm	49 375 28.0	
R10	56000 Ohm	49 377 45.0	
R11	2 x 33000 Ohm	49 377 42.0	
R12	0,82 M.Ohm	49 375 59.0	
R13	150 Ohm	49 875 14.0	
R14	0,82 M.Ohm	49 375 59.0	
R15	1,8 M.Ohm	49 377 63.0	
R16	0,22 M.Ohm	49 375 52.0	
R17	0,47 M.Ohm	49 375 56.0	
R18	0,82 M.Ohm	49 375 59.0	
R19	56000 Ohm	49 375 45.0	
R20	0,85 M.Ohm (0,65 + 0,2)	49 500 19.0	
R21	0,22 M.Ohm	49 375 52.0	
R22	1 M.Ohm	49 376 60.0	
R23	1 M.Ohm	49 376 60.0	
R24	0,82 M.Ohm	49 375 59.0	
R25	0,47 M.Ohm	49 375 56.0	
R26	1,8 M.Ohm	49 377 63.0	
R27	180 Ohm	49 375 15.0	
R28	1000 Ohm	49 375 24.0	
R29	1500 Ohm	49 375 26.0	
R30	12000 Ohm	49 375 37.0	
R31	10000 Ohm	49 375 36.0	
R32	1 M.Ohm	49 376 60.0	
R33	3,3 M.Ohm	49 377 66.0	
R34	3,3 M.Ohm	49 377 66.0	
R35	2200 Ohm	49 356 31.0	
R36	0,1 M.Ohm	49 375 48.0	
R37	18 Ohm	49 376 03.0	
R38	47000 Ohm	49 377 44.0	
R39	0,47 M.Ohm	49 375 56.0	
R40	33 Ohm	49 375 06.0	
R41	0,1 M.Ohm	49 375 48.0	
R42	1,8 M.Ohm	49 377 63.0	
R43	2200 Ohm	49 375 28.0	
R44	33 Ohm	49 376 06.0	
R45	100 Ohm	49 376 12.0	
R46	33 Ohm	49 375 06.0	
R47	22000 Ohm	49 375 40.0	
R48	1000 Ohm	49 375 24.0	
R49	1500 Ohm	49 356 29.0	1)

1) Only for execution A19.

Nr.	Value	Code number	Price
C1	3-30 pF	28 212 36.0	
C2	3-30 pF	28 212 36.0	
C3	3-30 pF	28 212 36.0	
C4	3-30 pF	28 212 36.0	
C5	3-30 pF	28 212 36.0	
C6	3-30 pF	28 212 36.0	
C7	3-30 pF	28 212 36.0	
C8	3-30 pF	28 212 36.0	
C9	22 pF	49 057 64.0	
C10	47 pF	49 055 24.0	
C11	10-490 pF	28 212 30.0	
C12	16-170 pF	28 211 31.0	
C13	47 pF	49 055 24.0	
C14	220 pF	49 055 32.0	
C15	56000 pF	49 127 23.0	
C16	47 pF	49 055 24.0	
C17	10 pF	49 055 16.0	
C18	56000 pF	49 128 23.0	
C19	56000 pF	28 212 36.0	
C20	3-30 pF	28 212 36.0	
C21	3-30 pF	28 212 36.0	
C22	3-30 pF	28 212 36.0	
C23	3-30 pF	28 212 36.0	
C24	3-30 pF	28 212 36.0	
C25	3-30 pF	28 212 36.0	
C26	3-30 pF	28 212 36.0	
C27	3-30 pF	28 212 36.0	
C28	100 pF	49 055 28.0	
C29	10-490 pF	see C11	
C30	220 pF	49 055 32.0	
C31	2.5 pF	28 206 62.0	
C32	220 pF	49 055 32.0	
C33	56000 pF	49 127 23.0	
C34	220 pF	49 055 32.0	
C35	56 pF	49 055 25.0	
C36	3-30 pF	28 212 36.0	
C37	33 pF	49 055 22.0	
C38	3-30 pF	28 212 36.0	
C39	3-30 pF	28 212 36.0	
C40	3-30 pF	28 212 36.0	
C41	3-30 pF	28 212 36.0	
C42	3-30 pF	28 212 36.0	
C43	3-30 pF	28 212 36.0	
C44	200 pF	28 212 08.1	
C45	12.5 pF	28 212 05.0	
C46	10-490 pF	see C11	
C47	3-30 pF	49 088 20.0	
C48	160 pF		
C49	390 pF	49 055 85.0	
C50	3-30 pF	28 212 36.0	
C51	6400 pF	28 194 05.0	
C52	56000 pF	49 128 23.0	
C53	390 pF	49 055 78.0	
C54	390 pF	49 055 78.0	
C55	30+70 pF	28 212 46.0	
C56	56000 pF	49 127 23.0	
C57	56000 pF	49 128 23.0	
C58	91 pF	28 194 38.0	
C59	18000 pF	49 127 17.0	
C60	30+70 pF	28 212 46.0	
C61	1800 pF	49 128 51.0	
C62	27000 pF	49 127 19.0	
C63	6.8 pF	49 055 14.0	
C64	56000 pF	49 128 23.0	
C65	100 pF	28 185 68.1	
C66	10 pF	49 055 16.0	
C67	56000 pF	49 128 23.0	
C68	27000 pF	49 127 19.0	
C69	30+70 pF	28 212 46.0	
C70	30+70 pF	28 212 46.0	
C71	100 pF	49 057 85.0	
C72	22000 pF	49 127 18.0	
C73	39000 pF	49 127 21.0	
C74	27000 pF	49 127 19.0	
C75	2200 pF	49 128 06.0	
C76	82 pF	49 055 27.0	
C77	4700 pF	49 129 10.0	
C78	0.1 pF	49 127 26.0	
C79	50000 pF	49 127 23.0	
C80	0.22 pF	49 127 30.0	
C81	50 pF	49 050 01.0	
C82	45 pF	49 055 22.0	
C83	47 pF		
C84	14 pF	49 029 01.0	
C85	56000 pF	49 128 23.0	
C86	56000 pF	49 128 23.0	
C87	220 pF	49 055 32.0	
C88	200 pF	28 212 08.1	

Nr.	Resistance	Code number	Price
S1	2.6 Ohm		
S2	5 Ohm		
S3	90 Ohm	GK 562 90.1	
S4	43 Ohm		
S5	1 Ohm		
S6	1 Ohm		
S7	1 Ohm		
S8	1 Ohm	GK 562 91.1	
S9	1 Ohm		
S10	1 Ohm		
S11	1 Ohm		
S12	1 Ohm		
S13	1 Ohm	GK 562 92.2	
S14	1 Ohm		
S15	2 Ohm		
S16	1 Ohm		
S17	245 Ohm		
S18	4 Ohm		
S19	470 Ohm	GK 562 89.1	
S20	40 Ohm		
S21	1 Ohm		
S22	1 Ohm		
S23	1 Ohm	GK 562 87.1	
S24	1 Ohm		
S25	1 Ohm		
S26	1 Ohm	GK 562 88.2	
S27	1 Ohm		
S28	2.5 Ohm		
S29	18 Ohm		
S30	3.5 Ohm	GK 562 93.1	
S31	35 Ohm	GK 563 01.0	
S32	1 Ohm		
S33	1 Ohm		
S35	1 Ohm		
S36	1 Ohm		
S37	1 Ohm	GK 562 95.4	
S38	1 Ohm		
S39	1 Ohm		
S40	1 Ohm		
S41	1 Ohm		
S42	1 Ohm	GK 562 96.2	
S43	1 Ohm		
S44	1 Ohm		
S45	1.5 Ohm		
S46	7.5 Ohm		
S47	1 Ohm	GK 562 97.4	
S48	2 Ohm	GK 562 99.0	
S49	7.5 Ohm		
S50	1.5 Ohm		
S51	7.5 Ohm	GK 562 98.5	
S52	5.5 Ohm	GK 563 00.0	
S53	3.5 Ohm		
S54	650 Ohm		
S55	1 Ohm		
S56	7 Ohm	GK 511 92.1	
S57	7 Ohm		
S58	4 Ohm	49 981 07.0	
S59	1250 Ohm	A1 001 68.2	
S60	100 Ohm		
S61	100 Ohm		
S62	1 Ohm	GK 512 18.0	
S63	1 Ohm		
S64	17 Ohm		
(245 V)			
S65	110 Ohm	GK 550 40.0	
S66	7.5 Ohm	GK 562 94.0	
S67	300 Ohm	GK 550 23.0	

) ex. U 19

## VALVES

B1	B2	B3	B4	B5	B6
EF22	ECH21	ECH21	FBL 21	EM4	1823

Pilotlemps: 8045D-00.

974 A

LIST OF SPARE PARTS AND TOOLS

When ordering please state always

- 1) code number
- 2) description
- 3) type number of receiver.

Fig.	Pos.	Description	Code number	Price
7	1	Cabinet . . . . .	GK 887 60.4	
7	2	Lens for magic eye . . . . .	23 669 05.0	
		Spring for lens . . . . .	A1 986 16.1	
7	4	Spekerdoth . . . . .		
7	5	Knob (colour 041) . . . . .	23 575 83.0	
7	6	Cap for pick-up switch (038) . . . . .	28 856 45.0	
7	7	Dial holder, left (038) . . . . .	23 664 27.0	
7	8	Dial (Sweden) . . . . .	A1 898 03.0	
7	8	Dial (Standard) . . . . .	A1 898 02.0	
7	9	Pointer . . . . .	A1 350 57.0	
		Pointer spindle . . . . .	A1 438 38.0	
		Spring for spindle . . . . .	A1 985 19.0	
7	10	Wave range pointer . . . . .	A1 350 74.0	
7	11	Dial holder, right (038) . . . . .	23 664 26.0	
7	12	Bearing for dial . . . . .	23 669 04.0	
7	13	Cover for bearing (038) . . . . .	23 664 25.2	
		Screw for cover . . . . .	07 720 77.0	
		Profile behind pointer . . . . .	A1 782 78.0	
8	21	Bracket for coil fixing . . . . .	28 084 83.1	
8	22	Tulle for variable condenser . . . . .	28 725 52.0	
8	23	Valve holder . . . . .	49 231 31.2	
8	24	Switch . . . . .	GK 887 17.0	
8	25	Socketplate for pick-up . . . . .	A1 340 42.0	
8	26	Loudspeaker switch . . . . .	GK 887 17.0	
8	29	Plate with pins . . . . .	A1 355 01.1	
		Cord clamp . . . . .	GK 920 05.0	
		Spring for tuning cable . . . . .	GK 735 48.0	
		Spring for stretching roll of pointer cable . . . . .	GK 735 47.0	
		Plats for mains connection . . . . .	28 869 19.0	
8	27	Knob for tension change over switch . . . . .	28 855 29.1	
8	28	Pick-up switch . . . . .	28 650 81.0	
8	30	Spring for wave range indicator . . . . .	A1 975 38.0	
8	31	Cable roll . . . . .	23 593 23.0	
		Coupling bush of variable condenser . . . . .	GK 115 95.0	
		Tuning spindle . . . . .	GK 616 49.0	
		Stop spring for these spindles . . . . .	GK 750 27.0	
		Coupling roll with carrier for wave range switch and tuning . . . . .	GK 824 44.0	
		Knurled screw for courser of indicator . . . . .	07 741 06.0	
		Bandwidth switch section . . . . .	GK 888 31.0	
		Wave length switch section 1 . . . . .	GK 888 27.0	
		" " " " " 1B . . . . .	GK 888 25.0	
		" " " " " 2, 4 and 6 . . . . .	GK 888 26.0	
		" " " " " 2B, 3B . . . . .	GK 888 24.0	
		" " " " " 3 . . . . .	GK 888 32.0	
		" " " " " 4B . . . . .	GK 888 28.0	
		" " " " " 5 . . . . .	GK 888 23.0	
		Tulle for bottom . . . . .	GK 446 78.0	
		Rearpanel . . . . .	GK 402 78.0	
		<b>LOUDSPEAKER (type 9632-R57)</b>		
		Clamping ring . . . . .	28 446 75.0	
		Paper ring . . . . .	28 445 88.0	
		Difusor . . . . .	23 666 60.2	
		<b>TOOLS</b>		
		Isolated trimming key . . . . .	23 685 66.0	
		Special trimming key . . . . .	09 993 01.0	
		15° jig . . . . .	09 992 44.0	
		Centring gauge . . . . .	09 992 41.0	
		Special coil lever . . . . .	09 992 86.0	
Components not appearing above will be found in the „General Parts List“.				

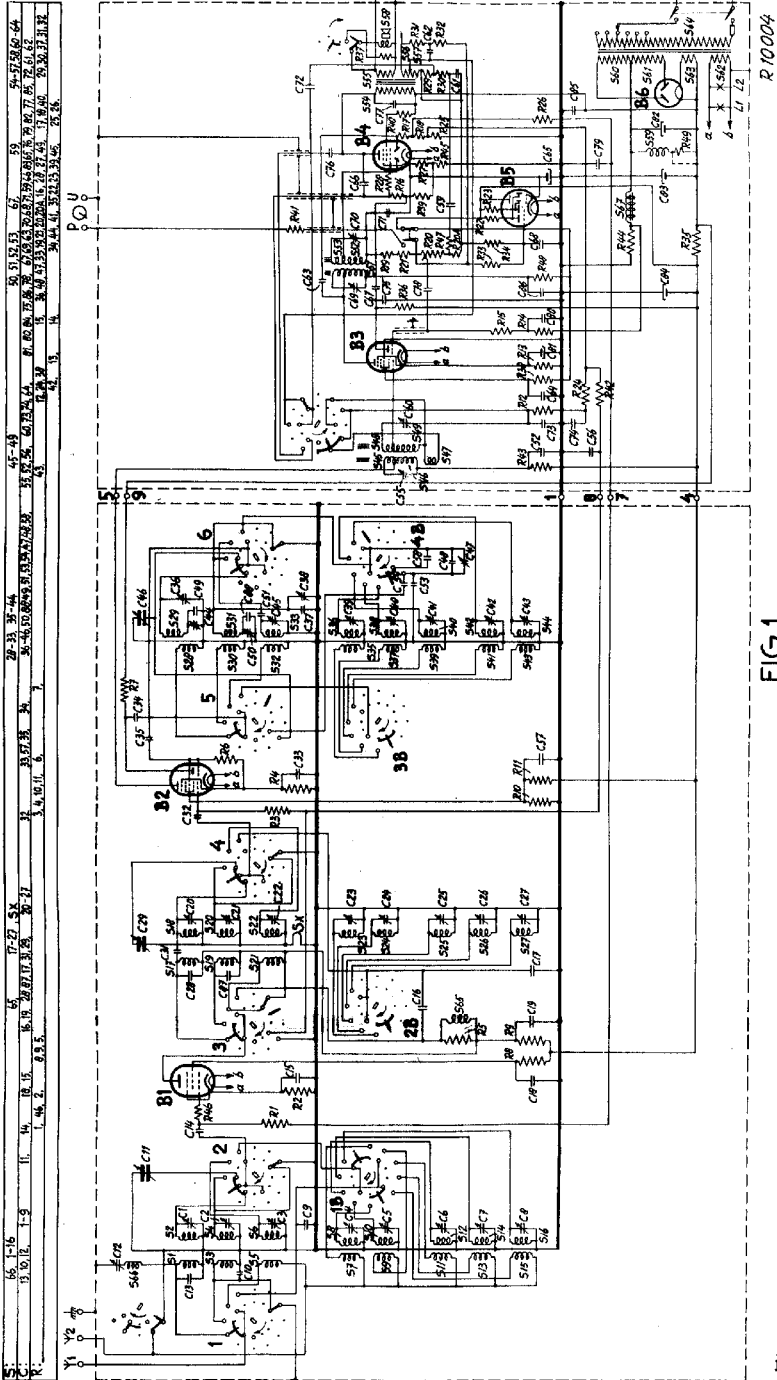

R 10004

FIG. 1

A. 533  
K. 853



S1: 11-16, 25, 26, 27, 41-44,	7-10, 23, 24, 35-40, 65,	Sx, 1-6, 17-21, 28-33,	66,	45-49
C: 1-8, 20-27, 19, 38-43, 36, 58, 47, 48, 51, 53, 54, 57, 9, 17, 16, 13, 31, 87, 49, 28, 35, 14, 32, 34, 44, 45, 88, 18, 11, 29, 46, 57, 33, 15, 12, 55, 60, 52,				
R: 5,	9, 3, 1, 4, 6,			8, 11, 10, 4, 6, 7, 2,

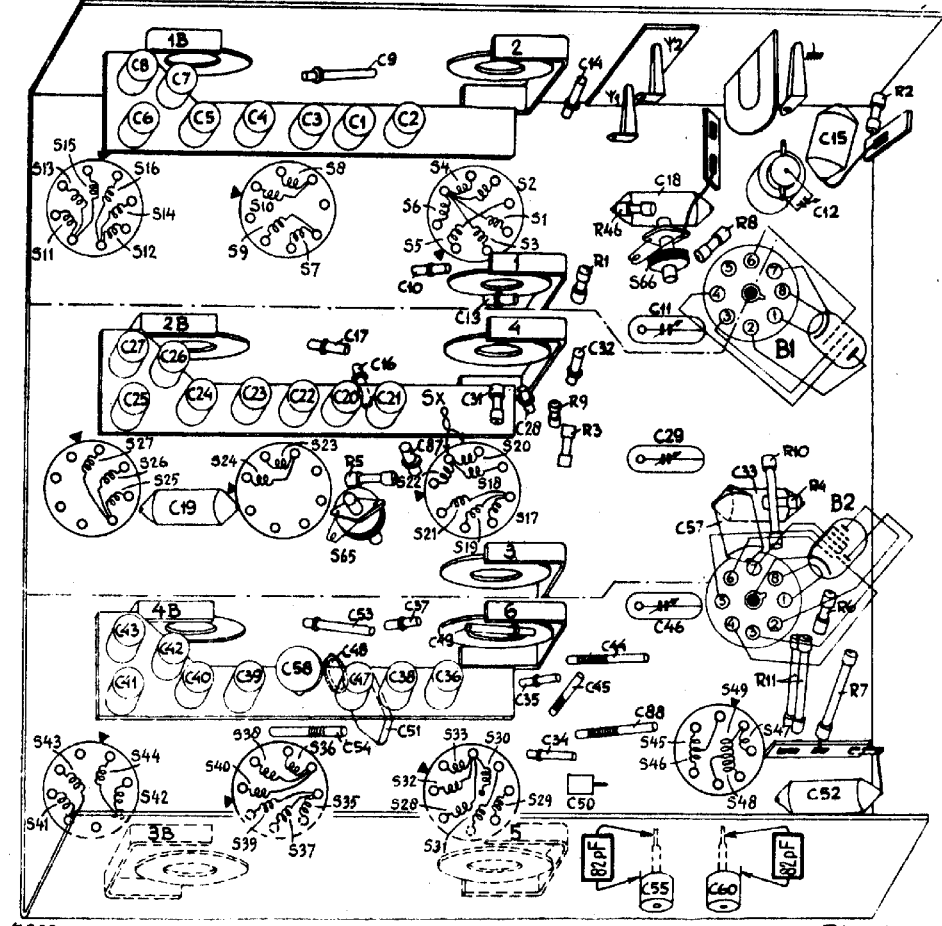



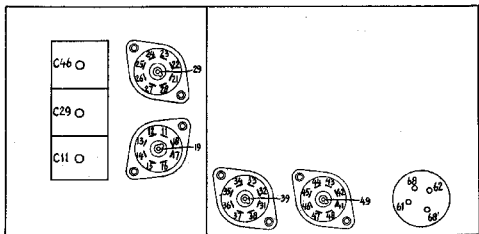

R 10016



R																
9	16	4 x 26				33	34	2 x 36		43	45	46	55	56	58	P
		MW	LW	KW	16m			A	B							
45	60	60	160	160	400	70	85	85								
10	4 x 12				13	15	22	23	24	25	27	32	33			
	MW	LW	KW	16m								R	R			
400	400	400	40	110	445	400	210	155	300	155	925	145				
11	14	17	29	39	42	44	47	54	57	68	68'					
	290	290	230	225	415	330	285	285	450	340	340					
12	11	18	19	21	28	31	37	38	41	48	52	53	61/62	S	L	U
	10	10	10	10	10	10	10	10	10	10	10	10	10	10	30	10
12	8 x Y1								2 x Y2		3 x C11			3 x C29		
	MW	LW	KW	16m	20m	25m	30m	50m	C	D	KW	LW	MW	MW	LW	KW
360	450	50	40	45	55	60	90	10	500	10	400	150	150	400	10	

C															
9	12	57													
	450	50													
10	22	25	32												
	330	100	400												
11	13	35	36												
	160	180	110												
12	46	56													
	70	440													

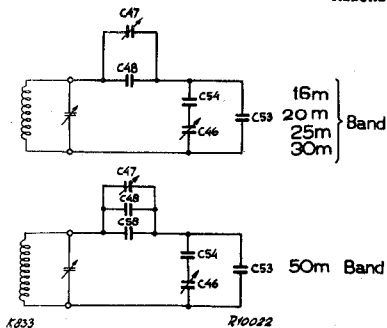

FIG. 4

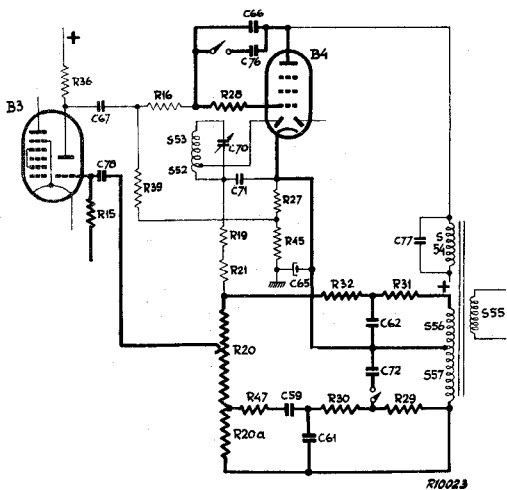
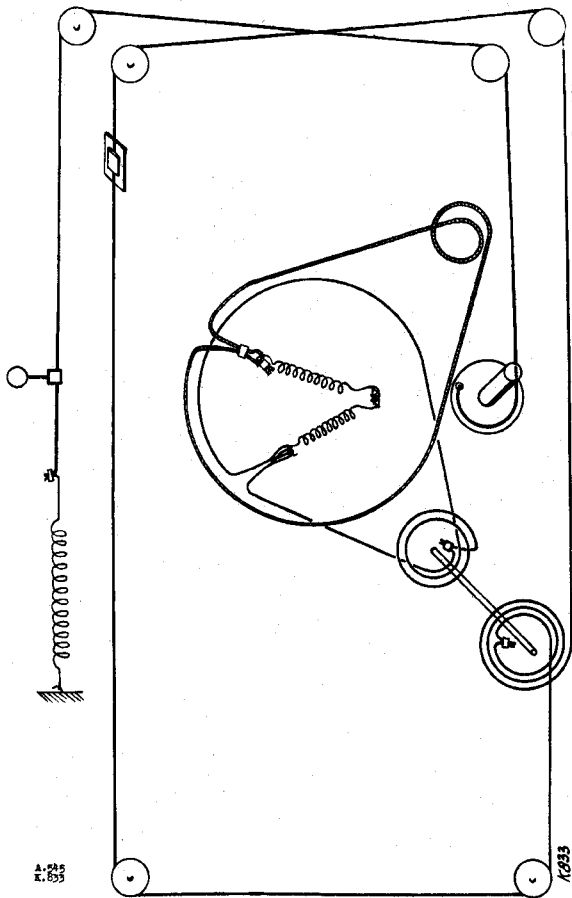

FIG. 5



R 10024

FIG. 6

1833

A. 285  
K. 833

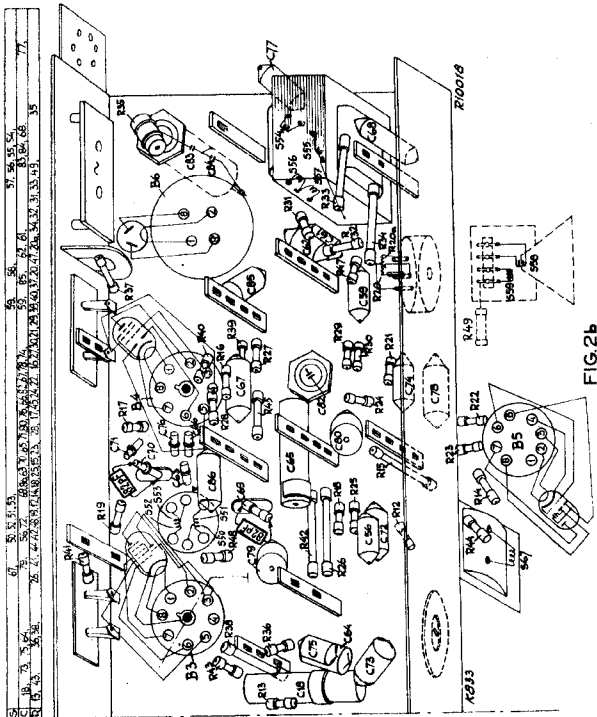

FIG. 2b

A. 542  
 K. 033

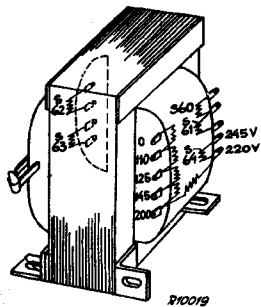

FIG. 2c

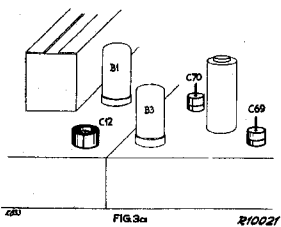
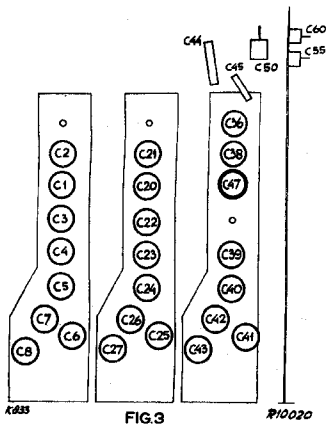

FIG. 3a

R10021